

DARRAN

Tablo

price list | effective August 2016 | updated 12.20.16



DESIGNED BY MICHAEL WOLK

**TABLE OF CONTENTS**

Product Index ..... 3  
 Seating Specification..... 4  
 General Information ..... 6  
 Limited Lifetime Warranty ..... 7  
 Damages | Returns | Repairs ..... 8  
 Ordering Information ..... 9  
 Freight..... 10  
 Seating Fabric & Leather Programs..... 11  
 COM/COL Form..... 12  
 Finishes..... 13  
 Platform - Bench..... 14  
 Platform - Seating Unit (Cushion) ..... 17  
 Seating Unit - Bench ..... 23  
 Seating Unit - Cushion ..... 25  
 Platform - Ottoman..... 29  
 Seating Unit - Ottoman ..... 30  
 Power and Data..... 31

DATE	PAGE	MODIFICATION	DESCRIPTION
8.23.16	23	COM pricing changed	COM 12 changed from 2737 to 2727

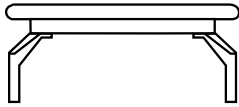

PAGE 14  
PLATFORM - BENCH

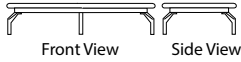

PAGE 15  
PLATFORM - BENCH

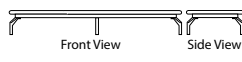

PAGE 16  
PLATFORM - BENCH

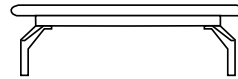

PAGE 17  
PLATFORM - SEATING UNITS  
(CUSHION)

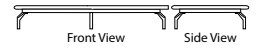

PAGE 18  
PLATFORM - SEATING UNITS  
(CUSHION)

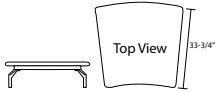

PAGE 19  
PLATFORM - INSIDE RADIUS  
SEATING UNIT (CUSHION)

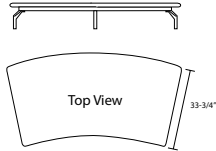

PAGE 20  
PLATFORM - INSIDE RADIUS  
SEATING UNIT (CUSHION)

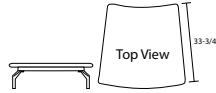

PAGE 21  
PLATFORM - OUTSIDE RADIUS  
SEATING UNIT (CUSHION)

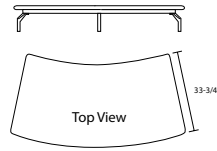

PAGE 22  
PLATFORM - OUTSIDE RADIUS  
SEATING UNIT (CUSHION)

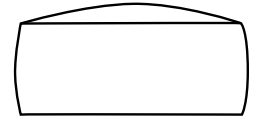

PAGE 23  
SEATING UNIT - BENCH



PAGE 24  
SEATING UNIT - BENCH

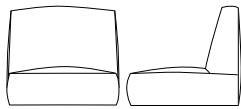

PAGE 25  
SEATING UNIT - CUSHION



PAGE 26  
SEATING UNIT - CUSHION



PAGE 27  
SEATING UNIT - CUSHION

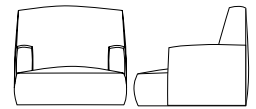

PAGE 28  
SEATING UNIT - CUSHION

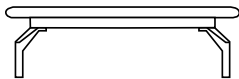

PAGE 29  
PLATFORM - OTTOMAN

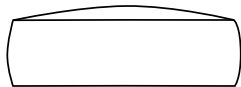

PAGE 30  
SEATING UNIT - OTTOMAN

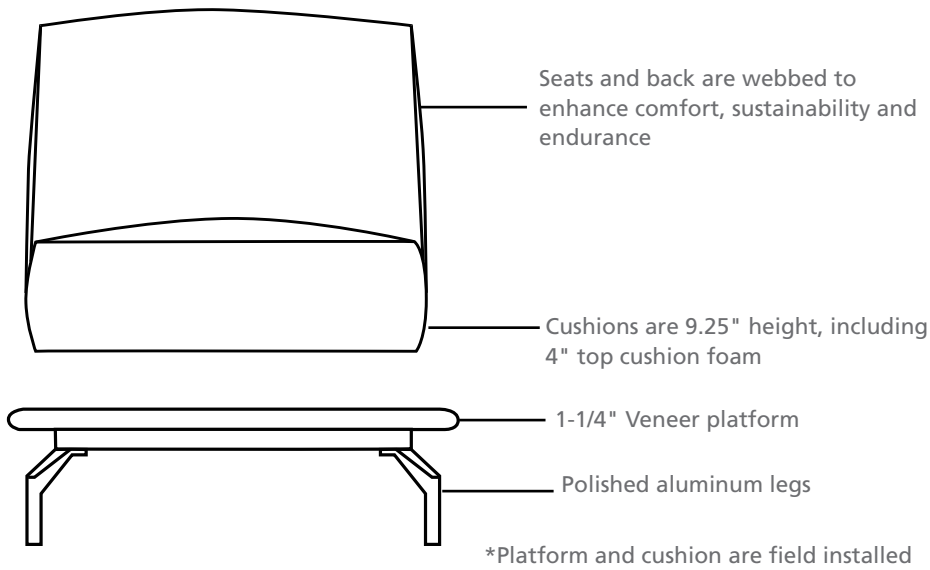

**MEASUREMENTS STATED BELOW ARE OVERALL DIMENSIONS INCLUDING PLATFORM.**

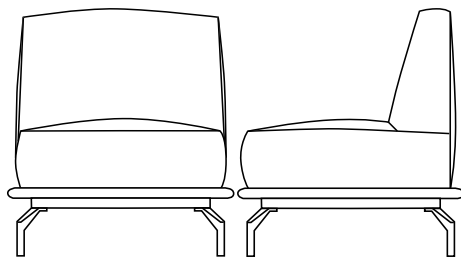

**ARMLESS**

Width = 33-3/4"  
 Depth = 33-3/4"  
 Height = 33"  
 Seat Width = 31-3/4"  
 Seat Depth = 21"  
 Seat Height = 17-3/4"

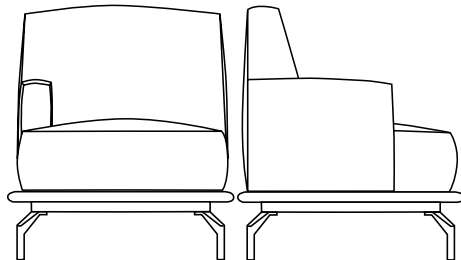

**ONE ARM CHAIR CUSHION**

Width = 32-3/4"  
 Depth = 32-3/4"  
 Height = 33"  
 Seat Width = 26-3/4"  
 Seat Depth = 21"  
 Seat Height = 17-3/4"  
 Arm Height: 22" from floor

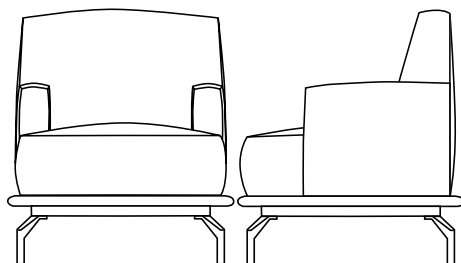

**LOUNGE CHAIR CUSHION**

Width = 32-3/4"  
 Depth = 32-3/4"  
 Height = 33"  
 Seat Width = 20-3/4"  
 Seat Depth = 21"  
 Seat Height = 17-3/4"  
 Arm Height: 22" from floor

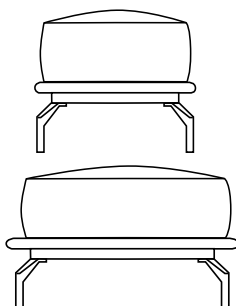

**19-1/2" ONE SEAT BENCH CUSHION**

Width = 19-1/2"  
 Depth = 19-1/2"  
 Height = 34"

**31-1/2" ONE SEAT BENCH CUSHION**

Width = 31-1/2"  
 Depth = 31-1/2"  
 Height = 34"

HEIGHTS STATED BELOW ARE PLATFORM HEIGHT WITHOUT CUSHION

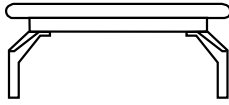

**21-3/4" DEPTH PLATFORM - BENCH**

Width = 21-3/4", 42-1/4", 62-3/4"

Depth = 21-3/4"

Height = 8-1/2"

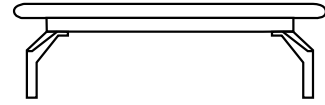

**33-3/4" DEPTH PLATFORM - SEATING UNIT**

Width = 33-3/4", 66-1/4"

Depth = 33-3/4"

Height = 8-1/2"

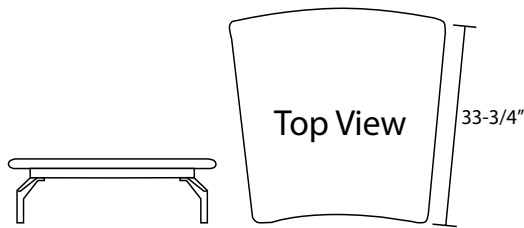

**15 DEGREE INSIDE RADIUS PLATFORM**

Width = 42-1/2"

Depth = 35-1/2"

Height = 8-1/2"

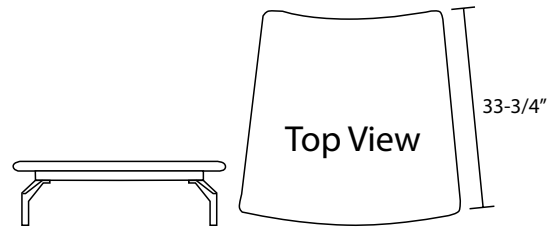

**15 DEGREE OUTSIDE RADIUS PLATFORM**

Width = 42-1/2"

Depth = 35-1/2"

Height = 8-1/2"

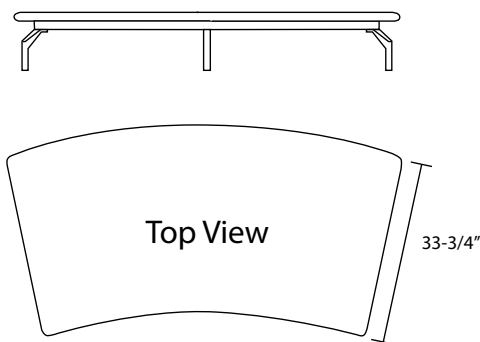

**30 DEGREE INSIDE RADIUS PLATFORM**

Width = 94-1/2"

Depth = 39"

Height = 8-1/2"

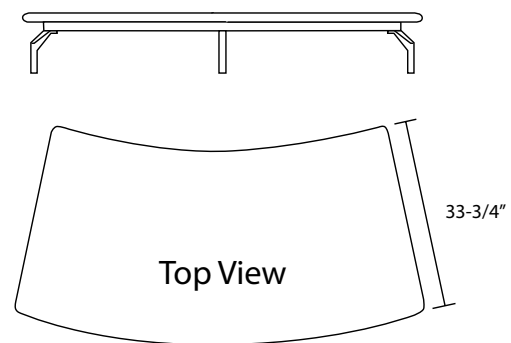

**30 DEGREE OUTSIDE RADIUS PLATFORM**

Width = 94-1/2"

Depth = 39"

Height = 8-1/2"



All DARRAN products are proudly manufactured in the U.S.A.

### FULLY ASSEMBLED

Unless otherwise noted, all products are fully assembled and ready to use, including add-on options.

### PERFORMANCE TESTED

All products are tested to ensure performance exceeds BIFMA / ANSI standards.

### FINISH TECHNOLOGY

DARRAN has continued its partnership with AkzoNobel Chemicals ([www.akzonobel.com](http://www.akzonobel.com)) to develop a new finish technology further improving indoor air quality with a coatings that meets today's environmental standards and supports LEED buildings.

ENVI-CT (Environmental Coatings Technology) utilizes advanced European finish technology to deliver a high-end furniture coatings with superior performance in appearance and durability, allowing DARRAN to deliver more sustainable products to our customers.

#### *ENVI-CT Advantages:*

- › ENVI-CT is a re-engineered high performance Top Coat
- › Exceptional hardness and clarity
- › Highly resistant to solvents and chemicals
- › Plasticizer Migration resistant
- › Excellent UV inhibitors for maximum color resistance
- › Exceeds current and proposed future Federal and State air quality requirements
- › Field Repairable
- › Dynamic chamber emissions tested and certified compliant to ANSI/BIFMA X 7.1 Standard / LEED 4.5 Standard for low – VOC emitting furniture.
- › Standard with Anti-microbial additive.



### ADVANTAGES

DARRAN has upgraded the standard Anti-microbial protection, to, the latest in Silver Ion Technology. DARRAN collaborated with the world's leader in finishing materials, to formulate an additive that will inhibit the growth of mold, mildew, fungus and bacteria on wood surfaces. This additive infuses Silver Ions into DARRAN's ENVI-CT (Environmental Coatings Finish Technology), creating a protective surface for the life of the furniture. The best part - is standard on all DARRAN Seating for no additional fee.



### COM/COL REQUEST

DARRAN has graded in fabric selection from Momentum, Maharam, CF Stinson, Paul Brayton Designs, Knoll Textiles and Designtex. In addition, DARRAN has graded in leather from Wollsdorf and Elmo. Should a material be desired that is not graded in, DARRAN will accommodate your request with our selected alliance textile partners. Please fill out the COM/COL form.

### TEXTILE FLAMMABILITY TESTING

All DARRAN seating products conform to California Technical Bulletin 117 as a minimum standard. CAL133 may require additional testing to ensure compliance.

## LIMITED LIFETIME WARRANTY

DARRAN Furniture Industries, Inc. ("DARRAN") warrants that each piece of furniture manufactured in its North Carolina Facilities will be free from defects in material and workmanship for as long as the original purchaser owns and uses the product. Subject to the limitations and exclusions herein, DARRAN, at its discretion and as the sole remedy under the DARRAN Limited Lifetime Warranty, will replace or repair a defective product or components with comparable product or components free of charge. This warranty is made only to the original purchaser from an authorized DARRAN dealer, for as long as that original purchaser owns and uses the product.

### LIMITATIONS: USE / CARE

- › Warranty is limited to normal single shift use.
- › Warranty is limited to generally accepted care and maintenance of natural wood products and environments.
- › Natural wood surfaces are subject to denting, scratching, and gauging if not properly used and cared for. Warranty is subject to use and care in accordance with the use and care instructions provided in the Product Care section of this site (including, but not limited to, the care and maintenance guide downloads linked thereon), available at [www.darran.com/product-care](http://www.darran.com/product-care), which are incorporated herein by reference.

### LIMITATIONS: MATERIALS / COMPONENTS

- › Chair Frames - 10 Years
- › Veneers / Laminates / Hardwoods - 10 Years
- › Custom / Modified Products - 3 Years
- › Foam Padding - 5 Years
- › Metal Accents / Glides - 10 Years
- › High Use Items - 5 Years (High Use Items include, but are not limited to, table arms, electrical components, ganging mechanisms, pneumatic lifts, and polymer based components)

### WARRANTY EXCLUSIONS

*Damage identified as carrier or installer related.*

- › Normal wear and tear of wood products during course of ownership.
- › Color, grain, or texture of natural wood materials, laminates, and other covering materials.
- › Damages or failures resulting from misuse, abuse, negligence, improper care, modifications, or relocation.
- › Non Commercial use or locations.
- › C.O.M (Customer's Own Material) specified by the Customer.
- › Textiles (which may be subject to a separate warranty from the textile manufacturer).

All Warranty Claims are subject to DARRAN-approved inspections. Disputes may involve independent third-party evaluation

### QUALITY ASSURANCE

DARRAN manufactures in accordance with the standards set by Architectural Woodwork Institute (AWI) for Quality Standards.

Every unit produced at DARRAN is completely inspected by an independent quality control team located within each plant whose emphasis is on assembly, finish, and final inspections

with empowerment to stop any unit not meeting DARRAN's high quality standards.

### LIGHT AND NATURAL FINISHES

The beauty of veneer and all wood products comes from the variations created by nature including color, grain, and texture. These variations are not considered defects and DARRAN's Limited Lifetime Warranty does not cover color, grain and texture variations associated with natural wood and grain seen in any finish color. DARRAN sets standards for veneer selections; however, variations, especially apparent in light/natural finishes, will occur from one piece to another even if they are finished at the same time.

Finishes such as Clear Maple, Light/Gunstock Walnut, and Clear/Caramel Cherry will display more natural characteristics due to their light stain. Grain, pattern and color from unit to unit are not guaranteed or warranted and products will not be replaced due to these variations. Exposure to light and age will cause darkening of natural wood products; therefore DARRAN cannot guarantee or warrant finish match of new products being placed with existing products in the field.

### TEXTILES/LEATHER

DARRAN does not manufacture textiles and does not warranty any textiles incorporated into its products (including, but not limited to, any warranty against colorfastness, crocking, wear abrasion, shrinking, stretching, tearing, wrinkling, durability, or dye lot match). Textiles are not covered under DARRAN's Limited Lifetime Warranty, but may be covered by a separate warranty from the textile manufacturer. Customers should contact the textile manufacturer directly with any concerns or claims regarding textiles.

### GENERAL

Performance questions will be tested to generally accepted practices and AWI guidelines and standards for wood veneer furniture. To obtain performance of the Limited Lifetime Warranty, the purchaser should contact in writing the authorized DARRAN representatives or current dealer who sold the product to the purchaser or mail the warranty claim to:

Warranty Department  
DARRAN Furniture Industries, Inc.  
P.O. Box 7614  
High Point, NC 27264  
Telephone: 336-861-2400      Toll Free: 800-334-7891  
Email: [warranty@darran.com](mailto:warranty@darran.com)

EXCEPT FOR THE LIMITED LIFETIME WARRANTY EXPRESSLY DESCRIBED HEREIN, DARRAN MAKES NO OTHER REPRESENTATION OR WARRANTY OF ANY KIND, EXPRESS OR IMPLIED. DARRAN MAKES NO WARRANTY OF MERCHANTABILITY OR FITNESS FOR A PARTICULAR PURPOSE, AND DARRAN WILL NOT UNDER ANY CIRCUMSTANCES BE LIABLE FOR ANY INCIDENTAL OR CONSEQUENTIAL DAMAGES, OR ANY INDIRECT OR SPECIAL DAMAGES.

**THE WARRANTY AS STATED ABOVE,  
SUPERSEDES ALL PREVIOUS WARRANTIES  
NO HASSLE FREIGHT DAMAGED MERCHANDISE**



DARRAN products are packed in specially designed cartons and padding that protects all edges and corners from damage. This is proven by an industry low damage rate of .0030% per total pieces shipped.

For qualified freight damage claims DARRAN will take responsibility for the claim and remedy processes including assuming total cost coverage from claim settlements.

(Some items may not qualify. Contact Factory for specific details.)

**QUALIFIED CLAIM CONDITIONS**

**VISIBLE CARTON DAMAGE**

1. Take digital pictures of the damaged carton and damaged furniture if visible damage is found upon delivery at the dock
2. Open all cartons with puncture or crushed corner damage.
3. Note any damage to the goods on the Carrier's freight bill as number of pieces damaged.

**CONCEALED DAMAGE**

1. Take digital pictures of the furniture as it sits partially unpacked. Also, photograph external and internal carton materials that correspond with the damaged area on the product.
2. Carton and damaged unit(s) must be located at the location matching the original delivery address for Carrier inspection.
3. Digital pictures must be provided of the damaged furniture and carton materials

For qualified claims per above contact DARRAN Customer Service Department at 1-800-334-7891 or complete DARRAN's online warranty report form within the 15 day limit. [www.darran.com/warranty-report](http://www.darran.com/warranty-report)

**NON-QUALIFIED CLAIM CONDITIONS**

1. Deliveries made to non-dock locations
2. Claims made after furniture is installed and/or removed from original delivery location
3. Carton and padding has been discarded
4. Carrier used was not DARRAN approved
5. Inspection reveals questionable damages

**REPLACEMENT ORDERS**

Replacement orders entered without replacement tagging or factory authorization is considered a new order without dispute, therefore full payment is expected and will be collected.

**RETURN SHIPMENTS**

DARRAN will not accept return of merchandise without a signed RA (return authorization) form.

DARRAN will specify the carrier to be used. Return bills of lading must be marked "Class 125" freight rate and a copy of the RA should be used as a packing list. All returns must be received by DARRAN within 30 days of the RA date or the products will be considered accepted by the customer.

All products being returned must be properly packed and protected to avoid freight damage. Whenever possible, use the original cartons in which the merchandise was shipped. Freight damage, signs of usage, missing parts, etc., will result in an

adjustment of any credit to be issued.

DARRAN will issue RA's for the following reasons:

1. Manufacturing defect (inspection required)
2. Order processing error by DARRAN
3. Shipping error
4. Mismarked carton / merchandise

**SPECIFICATION CHANGES**

We reserve the right to change without notice any dimension, style, or specification of any model in the DARRAN line. Dimensions shown in the price list are nominal. It is the buyer's responsibility to read specification carefully when matching existing goods is desired.

**MANUFACTURING DEFECTS**

Claims of manufacturing defects will not be entertained without prior consultation with DARRAN's warranty department. Unauthorized deduction in payment of invoices will not be allowed without prior factory approval. Unapproved deductions are subject to factor's late payment charges.

**DAMAGE CLAIMS**

Claims of manufacturing damage or freight damage reported as nicks, dents, scratches, etc. after installation of furniture will not be covered under warranty or freight claim.

**ATTENTION:** Damage claims involving glass or stone components must be inspected and damage noted on delivering freight bill to qualify for replacement.

**REPAIR CHARGES**

Factory authorization must be secured from DARRAN's warranty department prior to incurring repair charges. Warranty will utilize DARRAN's National Repair Service through the Furniture Medic Franchise ([www.furnituremedic.com](http://www.furnituremedic.com)).

Repair charge authorizations are based on:

- > Set travel rate
- > Average regional job rate
- > Factory set maximum repair time
- > Falsely reported defect claims are subject to local service charges being charged to dealer/distributor.

**FINISH MAINTENANCE**

Wood office furniture and wood finishes can retain their natural beauty for life if proper care is taken and a stable environment is provided. Fluctuations in humidity and temperature cause panels and solid wood components to expand and contract and may lead to panel warpage and finish "checking" or cracking. Prolonged exposure of furniture to dry heat during winter months should be avoided. Careful examination of interior wood trim may indicate a damaging dry environment. If open joints, splits and cracks are appearing in trimwork consult with a HVAC professional for appropriate remedy.

DARRAN finishes are field repairable should damage occur. Professional furniture repair services are recommended. Regular cleaning with a non-silicone polish is recommended.

**ORDERING**

All orders should be emailed, mailed or transmitted by fax to:

DARRAN Furniture Industries, Inc.  
P.O. Box 7614  
High Point, NC 27264  
Email: orders@darran.com  
Fax: 336-861-6485

DARRAN will only accept orders from authorized Dealers. All orders must be accurate and detailed. All Quick Ship orders must contain Quick Ship product ONLY. Orders should be separated and submitted according to lead time. Orders must contain Quick Ship code "QS" or have designated Quick Ship lead time to ensure correct order entry. Orders that contain multiple lead time products will be entered as one order and scheduled with the most extended lead time.

**CREDIT APPROVAL**

All orders are subject to credit approval for open account. All new accounts must be approved by a local DARRAN Sales Representative and should submit current financial information and trade references to:

DARRAN Furniture Industries, Inc. ATTN: Credit Department  
P.O. Box 7614  
High Point, NC 27264  
Telephone: 336-861-2400 Toll Free: 800-334-7891  
Fax: 336-861-2512

Orders submitted without accounts pre-approval or credit approval are subject to acceptance with lead times scheduled only after approval dates.

**LEAD TIME SCHEDULE**

DARRAN cannot assign a firm lead time until Credit approval and order accuracy are complete. Extended lead times due to credit or information delays are the responsibility of the Buyer.

**ORDER DELAY / HOLD**

Due to the committed manufacturing cost on Quick Ship processes, DARRAN cannot delay or hold orders, either in process or after completion.

**CANCELLATION AND ORDER CHANGES - FEES**

Acknowledged orders are considered firm orders and therefore not subject to cancellation or change. However, in the event we are able to stop an order prior to manufacturing process, we will consider cancellation or changes with a reprocessing fee of \$40.00 Net. Exceptions: Quickship orders cannot be changed or canceled after the 3rd business date after acknowledgment. Qualified changes/cancellations will be assessed a \$40.00 Net processing fee.

Changes or cancellation of order with special options or custom quoted items are also subject to additional material and vendor fee costs, plus a DARRAN special/custom reprocessing fee of \$100 NET.

**ORDER MOVEUPS**

Should an original scheduled ship date need to be improved, the Factory must be contacted 15 business days prior to the desired ship date. Move ups are subject to schedule availability.

**ORDER ACKNOWLEDGMENT**

Upon credit approval your order will be acknowledged and identified by an order number. When making reference to your order, please use this order number. Your acknowledgment is a detailed description of our interpretation of your order, pricing, shipping information, and estimated delivery date.

If you have not received an Acknowledgment within 10 Days of order issue, contact Customer Service immediately. All Quick Ship order acknowledgments will be faxed or emailed upon request to speed processing. Please read your acknowledgment carefully for correctness and notify DARRAN immediately of any discrepancies. Failure to notify relieves DARRAN from error liability.

Order acknowledgment is the final agreement between DARRAN and the customer superseding all previous communications regarding the order. DARRAN will not be responsible for errors made on orders placed by phone without written confirmation.

**SELLING INFORMATION**

Possession of this price list does not in itself constitute the right to sell DARRAN products. DARRAN products are sold and distributed through authorized dealerships. Contact factory for a listing of local representatives and dealerships.

**INVOICE TERMS**

Standard terms are NET 30 days. Finance charges of 1-1/2% will be added to delinquent accounts after 45 Days and for each 30 Days thereafter until paid.

Complaints involving newly received merchandise must be reported within 10 days from receipt to qualify for full invoice remittance suspension or term extension. Otherwise only items in dispute can be suspended from payment of invoice within terms.

**WAREHOUSE/STORAGE**

DARRAN will determine order warehousing approvals on a case by case basis. Orders that can be accommodated will be limited to a max of 30 days storage and must be invoiced at time of storage. Orders that exceed factory storage capacity will be transferred to local storage facilities subject to current storage rates and handling-transit charges. Storage charges must be paid prior to order release to shipping.

## SHIPPING SCHEDULE

When requested, DARRAN will assist in locating special express carriers that may have short transit times. These services may exceed our prepaid freight costs; therefore, pricing is limited to the Freight Excluded formula with special express charges added to the invoice.

For special deliveries, DARRAN will make every effort to meet the appointed time; however DARRAN will not be responsible for any additional charges for late deliveries beyond our control.

## PRICES

- › All prices shown are suggested list prices with freight included where indicated.
- › Freight allows delivery to one qualified destination.
- › Within the Continental USA, all orders above \$1,500 net are shipped FOB factory, freight prepaid and allowed. All orders less than \$1,500 net will be subject to a \$100 net freight charge.

## CALL BEFORE DELIVERY REQUEST

DARRAN will arrange for carriers to call before delivery when requested.

Important Non-Qualified Destinations DARRAN Prepaid Freight Pricing does not include delivery to:

- › Residential Areas
- › Restricted Commercial Areas
- › No Dock Locations
- › Inside delivery/setup service

Orders received and installed without professional Furniture Installers voids all Warranty Coverage.

## CARRIER SELECTION

DARRAN selects and uses only carriers specialized in furniture transportation. Customer requested carriers can be authorized using Freight Excluded pricing with invoice add-on.

## SPECIFIC DELIVERY TIMES

DARRAN will assist in coordinating a requested delivery time from a carrier. DARRAN makes no guarantees and accepts no responsibility for such services as DARRAN has no control over possible carrier hazards. To ensure specific time arrival, we recommend arranging single stop, designated load carriers. Less than trailer load (LTL) shipments cannot be coordinated for a guaranteed delivery time.

## EXPRESS CARRIERS

When requested DARRAN will assist in locating special express carriers that may have short transit times. These services exceed our prepaid freight cost, therefore, pricing is limited to the Freight Excluded formula with special express charges added to invoice.

**SEATING FABRIC & LEATHER PROGRAMS**

DARRAN has partnered with some of the most prestigious fabric suppliers of the office furniture industry to bring you quality fabrics that are engaging designs, environmentally friendly, and durable for years to come. The majority of fabrics we have graded-in are in heavy supply making it most likely available on our Quickship program, however, we cannot guarantee stock. If you do not see the fabric you wish to include in a project, please contact our Factory to see if this pattern can be graded-in at 800.334.7891.

**FABRICS**

Please visit our Seating Fabrics page at [darran.com/fabrics](http://darran.com/fabrics)

Momentum Textiles	800.366.6839
<a href="http://www.momentumtextiles.com">www.momentumtextiles.com</a>	
Maharam	800.645.3943
<a href="http://www.maharam.com">www.maharam.com</a>	
CFStinson	800.841.6279
<a href="http://www.cfstinson.com">www.cfstinson.com</a>	
Paul Brayton	800.882.4720
<a href="http://www.paulbraytondesigns.com">www.paulbraytondesigns.com</a>	
Knoll Textiles	866.565.5858
<a href="http://www.knolltextiles.com">www.knolltextiles.com</a>	
DesignTex	800.797.4949
<a href="http://www.designtex.com">www.designtex.com</a>	
Mayer Fabrics	800.428.4415
<a href="http://www.mayerfabrics.com">www.mayerfabrics.com</a>	

**LEATHERS**

Please visit our Seating Fabrics page at [darran.com/leathers](http://darran.com/leathers)

Wollsdorf	336.884.5005
<a href="http://www.wollsdorf.com">www.wollsdorf.com</a>	
Elmo Leather	732.549.5151
<a href="http://www.elmoleather.com">www.elmoleather.com</a>	

Application instructions must be specified on the purchase order or COM / COL submission form. In the absence of application instructions, DARRAN will apply materials accordingly.

**CAL117**

All DARRAN seating products conform to California Technical Bulletin 117 as a minimum standard.

**CAL133**

To meet the California Technical Bulletin 133 flammability regulation, a combination of proper materials must be used to pass, as it tests the fire resistance of a finished product. Flame resistant fabric, a fire blocker material and special foam must be used to pass CAL133 fire codes.

Testing is available for all seating products with the following fees and considerations:

Fabric Width	Plain Fabric	2"-14" Repeat	15"-19" Repeat	20"-27" Repeat	28"-36" Repeat
54"	0	15%	20%	25%	30%
53"	6%	19%	24%	28%	36%
52"	13%	23%	28%	33%	38%
51"	19%	26%	31%	36%	41%
50"	25%	30%	35%	40%	45%
49"	30%	35%	40%	45%	50%
48"	35%	40%	45%	50%	55%
47"	45%	50%	55%	58%	65%

- › If laboratory certification is not required, any style can be manufactured to comply with California Technical Bulletin 133 for \$ 75 list per yard required. (Customer's Own Materials must factor in additional yardage requirements based on repeat.)
- › The purchase order must clearly indicate the requirement of California Technical Bulletin 133.
- › If laboratory California Technical Bulletin 133 certification is required, the cost of testing a chair is \$820 NET, plus the cost of the chair and covering material.
- › An additional lead time of 4 to 6 weeks is required for testing for CAL133.
- › Once testing is completed, we will provide a certification letter specific to the sample tested for CAL133.
- › DARRAN's manufacturing procedures for California TB 133 compliance are based on the testing of representative styles with specific fabrics. Please contact Customer Service for an updated list of tested models.
- › A copy of test certification is available upon request.

**COMBINATION FABRICS**

DARRAN is pleased to offer customers the design freedom of combination fabrics. When using fabric, vinyl or leather combinations, pricing will be as follows:

- › When combining two materials of the same grade, pricing will be specified grade + 5%.
- › If combining two materials of different grades or leather/fabric combination, use the highest grade/price + 5%.
- › If using COM or COL, pricing will be COM or COL + 5%. If both COM + COL are used in combination, use COL + 5%

**COM/COL ORDERING INSTRUCTIONS**

Please complete the COM Submission Form prior to ordering the fabric from the supplier. All COM fabrics must be approved prior to order submission. Please refer to our website or contact DARRAN Seating Customer Service for an updated list of preapproved COM fabrics. Application instructions must be specified on the purchase order or COM/COL submission form. In the absence of application instructions, DARRAN will apply materials in the best manner and cannot be held responsible for tailoring or application objections after upholstery. COM orders will be scheduled for production after receipt of the material. Packages must be clearly marked and the fabric must be first quality, continuous yardage.

**COM/COL YARDAGE REQUIREMENTS**

The yardage requirements stated in this price list for each style are calculated using 54" wide, non-directional fabrics. For fabrics with a different width or for patterns with repeats, please refer to the below chart to calculate the additional percent of fabric required:

NOTE: Prior To Completion Of This Form, Please Refer To Our Graded In Materials Program For Preapproved Fabrics/Leathers.

**COM/COL APPROVAL**

DARRAN Furniture Industries  
 2402 Shore Street, High Point, NC 27263  
 ATTN: Seating Division / COM/COL Approval  
 TAG: DARRAN Purchase Order Number

**SHIPPING APPROVED COM/COL MATERIALS**

DARRAN Furniture Industries  
 2402 Shore Street, High Point, NC 27263  
 ATTN: Seating Division / COM/COL Approval  
 TAG: DARRAN Purchase Order Number

Please complete this form, attach a 6" x 6" sample and mail to the COM/COL APPROVAL address shown above. This form can also be downloaded from our website at [www.darran.com/leathers](http://www.darran.com/leathers) OR [www.darran.com/fabrics](http://www.darran.com/fabrics)

Purchase Order # _____	Chair Style _____
Dealer's Name _____	Manufacturer _____
Contact _____	Pattern Name _____
Address _____	Pattern Color _____
Telephone _____	Content _____
Email _____	Repeat _____

Please specify any special requirements and check the application below.

---



---

**COM/COL**

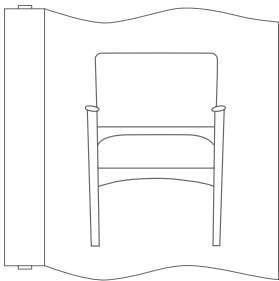

**RAILROAD**

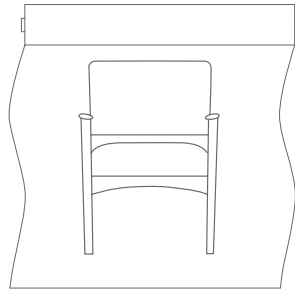

**SETUP**

In the absence of application instructions, DARRAN will apply the material in the best manner and cannot be held responsible for tailoring or application objections after upholstering. Unless otherwise instructed on the purchase order, excess COM materials will be recycled at the discretion of DARRAN after six months of the original product ship date.

The COM approval solely pertains to the application of the fabric onto the specified DARRAN seating product. DARRAN's approval or acceptance does not constitute any responsibility or warranty to the overall appearance, durability, flammability, defects, dye lot variations or colorfastness of the COM. It is the customer's responsibility to ensure the COM meets CAL 117 compliance and are first quality continuous goods.

**ATTACH 6" X 6"  
 FABRIC/LEATHER  
 SAMPLE HERE**

**NOTE**  
 Actual Fabric/Leather samples needed instead of digital images. If digital images are sent in lieu of samples, DARRAN will only verify the pattern and will not take responsibility for color variances that cannot be verified due to printing restrictions

**FINISHES**

WAC Amber Cherry  
 WRC Caramel Cherry  
 WIC Crimson Cherry  
 WEC Ebony Cherry  
 WHC Honey Cherry  
 WOC Koko Cherry  
 WSC Scotch Cherry  
 WWC Wheat Cherry  
 WAM Alabaster Maple  
 WCM Clear Maple  
 WWM Wheat Maple  
 WBO Blush Oak  
 WMO Mocha Oak  
 WTO Toast Oak  
 WWO Wheat Oak  
 WOW Clear Walnut  
 WEW Executive Walnut  
 WRW Gray Luster Walnut  
 GWG Gunstock Walnut  
 WJW Judicial Walnut  
 WNW Natural Walnut  
 WST Studio Teak Walnut  
 WWP Full Fill Designer White

Send 3x3 or larger finish chip for color match. Custom finish upcharge is 3% or \$250 Net (whichever is greater).

**FINISH**

ENVI-CT Green Certified European Technology Coatings Finish with Anti-microbial protection.

Frames are constructed of kiln-dried European beech and coordinate with all DARRAN casegood finishes.

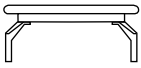

**21 3/4" DEPTH ONE SEAT BENCH PLATFORM**

**STANDARD FEATURES**

- 1 1/4" Platform
- Polished Aluminum legs
- Platforms for a cushion feature a route to reduce unit weight

- Cushions (ordered separately) attach to platform with 4 bolts (Field Assembly Required). Cushions are reversible on platform.
- Each flush cut option reduces the platform width 5/8"

**NOTES**

- If platform for cushion is desired, use with 19-1/2" bench cushion
- Power Options not available on Platform for Cushion

[CLICK HERE TO VIEW PRODUCT INDEX](#)

**1 SELECT A STYLE**

DIMENSIONS	STYLE NUMBER	LIST PRICE	STYLE NUMBER	LIST PRICE	STYLE NUMBER	LIST PRICE
W" x D" x H"	"W" Veneer Veneer Top Veneer Chassis		"G" HPL High Pressure Laminate Top Veneer Chassis		"M" TFL Thermally Fused Laminate Top Thermally Fused Laminate Chassis	
<b>Platform for Cushion (Cushion not Included)</b>						
21-3/4 x 21-3/4 x 8-1/2	25 TAB2121RPT01	640	"G" Option N/A		"M" Option N/A	
<b>Table Platform</b>						
21-3/4 x 21-3/4 x 8-1/2	35 TAB2121RPT00	640	"G" Option N/A		"M" Option N/A	

**2 SELECT A FINISH**

"W" Veneer	"G" HPL	"M" TFL	Finish
WAC	-	-	Amber Cherry
WRC	-	-	Caramel Cherry
WIC	-	-	Crimson Cherry
WEC	-	-	Ebony Cherry
WHC	-	-	Honey Cherry
WOC	-	-	KoKo Cherry
WSC	-	-	Scotch Cherry
WWC	-	-	Wheat Cherry
WAM	-	-	Alabaster Maple
WCM	-	-	Clear Maple
WWM	-	-	Wheat Maple
WBO	-	-	Blush Oak
WMO	-	-	Mocha Oak
WTO	-	-	Toast Oak
WWO	-	-	Wheat Oak
WOW	-	-	Clear Walnut
WEW	-	-	Executive Walnut
WRW	-	-	Gray Luster Walnut
WGW	-	-	Gunstock Walnut
WJW	-	-	Judicial Walnut
WNW	-	-	Natural Walnut
WTW	-	-	Studio Teak Walnut
WWP	-	-	Full Fill Designer White

**3 SELECT AN EDGE**



Oval

**4 SELECT HARDWARE**

Hardware Option Not Available

**5 OPTIONS**

**FLUSH CUT**

- FC-B: Flush Unit Both Sides(Facing) for Ganging - \$95
- FC-L: Flush Unit Left (Facing) for Ganging - \$95
- FC-R: Flush Unit Right(Facing) for Ganging - \$95

**POWER**

- AirCharge offers a convenient way to charge any Qi compatible smartphone or device without the need to carry charging cables or find an available power outlet. Devices not equipped with the Qi technology, can be adapted to accept a charge with the AirCharge Wireless Receiver.
- ACWG: AirCharge Wireless Grommet (Black Aluminum) \$575
  - ACWR: AirCharge Wireless Charging Receiver with Lightning Cable \$170
  - Cover Power Pod (Linking/Non-Linking)
  - PD-Cove: Non-Linking Rectangle Power Unit - \$550, For Table Top
  - COV-DCH: Hardwire Infeed, 1 Linking Cove unit - \$710
  - COV-DCP: Plug Infeed, 1 Linking Cove unit - \$765
  - COV-DCL: Additional Units (includes 1 Linking Cove unit + 72" jumpers) - \$575

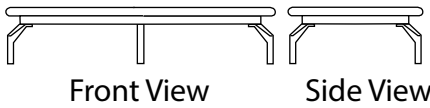

**21 3/4" DEPTH TWO SEAT BENCH PLATFORM**

**STANDARD FEATURES**

- 1 1/4" Platform
- Polished Aluminum legs
- Platforms for a cushion feature a route to reduce unit weight

- platform with 4 bolts (Field Assembly Required). Cushions are reversible on platform.
- Center leg is a black recessed support
- Each flush cut option reduces the platform width 5/8"

**NOTES**

- If platform for cushion is desired, use with 19-1/2" bench cushion
- AirCharge not available on TAB4221RPT05
- Cushions (ordered separately) attach to

[CLICK HERE TO VIEW PRODUCT INDEX](#)

**1 SELECT A STYLE**

DIMENSIONS	STYLE NUMBER	LIST PRICE	STYLE NUMBER	LIST PRICE	STYLE NUMBER	LIST PRICE
W" x D" x H"	"W" Veneer Veneer Top Veneer Chassis		"G" HPL High Pressure Laminate Top Veneer Chassis		"M" TFL Thermally Fused Laminate Top Thermally Fused Laminate Chassis	
<b>Platform for Left Facing Cushion (Cushion not Included)</b>						
42-1/4 x 21-3/4 x 8-1/2	45 TAB4221RPT02	988	"G" Option N/A		"M" Option N/A	
<b>Platform for Right Facing Cushion (Cushion not Included)</b>						
42-1/4 x 21-3/4 x 8-1/2	45 TAB4221RPT03	988	"G" Option N/A		"M" Option N/A	
<b>Platform for Left &amp; Right Facing Cushion (Cushion not Included)</b>						
42-1/4 x 21-3/4 x 8-1/2	40 TAB4221RPT05	1310	"G" Option N/A		"M" Option N/A	
<b>Table Platform</b>						
42-1/4 x 21-3/4 x 8-1/2	55 TAB4221RPT00	1310	"G" Option N/A		"M" Option N/A	

**2 SELECT A FINISH**

"W" Veneer	"G" HPL	"M" TFL	Finish
WAC	-	-	Amber Cherry
WRC	-	-	Caramel Cherry
WIC	-	-	Crimson Cherry
WEC	-	-	Ebony Cherry
WHC	-	-	Honey Cherry
WOC	-	-	KoKo Cherry
WSC	-	-	Scotch Cherry
WWC	-	-	Wheat Cherry
WAM	-	-	Alabaster Maple
WCM	-	-	Clear Maple
WWM	-	-	Wheat Maple
WBO	-	-	Blush Oak
WMO	-	-	Mocha Oak
WTO	-	-	Toast Oak
WWO	-	-	Wheat Oak
WOW	-	-	Clear Walnut
WEW	-	-	Executive Walnut
WRW	-	-	Gray Luster Walnut
WGW	-	-	Gunstock Walnut
WJW	-	-	Judicial Walnut
WNW	-	-	Natural Walnut
WTW	-	-	Studio Teak Walnut
WWP	-	-	Full Fill Designer White

**3 SELECT AN EDGE**



Oval

**4 SELECT HARDWARE**

Hardware Option Not Available

**5 OPTIONS**

**FLUSH CUT**

- FC-B: Flush Unit Both Sides(Facing) for Ganging - \$95
- FC-L: Flush Unit Left (Facing) for Ganging - \$95
- FC-R: Flush Unit Right(Facing) for Ganging - \$95

**POWER**

- AirCharge offers a convenient way to charge any Qi compatible smartphone or device without the need to carry charging cables or find an available power outlet. Devices not equipped with the Qi technology, can be adapted to accept a charge with the AirCharge Wireless Receiver.
- ACWG: AirCharge Wireless Grommet (Black Aluminum) \$575
  - ACWR: AirCharge Wireless Charging Receiver with Lightning Cable \$170
  - Cover Power Pod (Linking/Non-Linking)
  - PD-Cove: Non-Linking Rectangle Power Unit - \$550, For Table Top
  - COV-DCH: Hardwire Infeed, 1 Linking Cove unit - \$710
  - COV-DCP: Plug Infeed, 1 Linking Cove unit - \$765
  - COV-DCL: Additional Units (includes 1 Linking Cove unit + 72" jumpers) - \$575





**21 3/4" DEPTH THREE SEAT BENCH PLATFORM**

**STANDARD FEATURES**

- 1 1/4" Platform
- Polished Aluminum legs
- Platforms for a cushion feature a route to reduce unit weight

- platform with 4 bolts (Field Assembly Required). Cushions are reversible on platform.
- Center leg is a black recessed support
- Each flush cut option reduces the platform width 5/8"

**NOTES**

- If platform for cushion is desired, use with 19-1/2" bench cushion
- AirCharge not available TAB6221RPT08
- Cushions (ordered separately) attach to

[CLICK HERE TO VIEW PRODUCT INDEX](#)

**1 SELECT A STYLE**

DIMENSIONS		STYLE NUMBER	LIST PRICE	STYLE NUMBER	LIST PRICE	STYLE NUMBER	LIST PRICE
W" x D" x H"	WGT	"W" Veneer Veneer Top Veneer Chassis		"G" HPL High Pressure Laminate Top Veneer Chassis		"M" TFL Thermally Fused Laminate Top Thermally Fused Laminate Chassis	
<b>Platform for Left Facing Cushion (Cushion not Included)</b>							
62-3/4 x 21-3/4 x 8-1/2	70	TAB6221RPT02	1310	"G" Option N/A		"M" Option N/A	
<b>Platform for Center Cushion (Cushion not Included)</b>							
62-3/4 x 21-3/4 x 8-1/2	70	TAB6221RPT04	1310	"G" Option N/A		"M" Option N/A	
<b>Platform for Right Facing Cushion (Cushion not Included)</b>							
62-3/4 x 21-3/4 x 8-1/2	70	TAB6221RPT03	1310	"G" Option N/A		"M" Option N/A	
<b>Platform for Left &amp; Center Facing Cushion (Cushion not Included)</b>							
62-3/4 x 21-3/4 x 8-1/2	60	TAB6221RPT06	1310	"G" Option N/A		"M" Option N/A	
<b>Platform for Center &amp; Right Facing Cushion (Cushion no Included)</b>							
62-3/4 x 21-3/4 x 8-1/2	60	TAB6221RPT07	1310	"G" Option N/A		"M" Option N/A	
<b>Platform for Left &amp; Right Facing Cushion (Cushion not Included)</b>							
62-3/4 x 21-3/4 x 8-1/2	60	TAB6221RPT05	1310	"G" Option N/A		"M" Option N/A	
<b>Platform with Left, Center &amp; Right Facing Cushions (Cushion not Included)</b>							
62-3/4 x 21-3/4 x 8-1/2	50	TAB6221RPT08	1310	"G" Option N/A		"M" Option N/A	
<b>Table Platform</b>							
62-3/4 x 21-3/4 x 8-1/2	80	TAB6221RPT00	1310	"G" Option N/A		"M" Option N/A	

**2 SELECT A FINISH**

"W" Veneer	"G" HPL	"M" TFL	Finish
WAC	-	-	Amber Cherry
WRC	-	-	Caramel Cherry
WIC	-	-	Crimson Cherry
WEC	-	-	Ebony Cherry
WHC	-	-	Honey Cherry
WOC	-	-	KoKo Cherry
WSC	-	-	Scotch Cherry
WWC	-	-	Wheat Cherry
WAM	-	-	Alabaster Maple
WCM	-	-	Clear Maple
WWM	-	-	Wheat Maple
WBO	-	-	Blush Oak
WMO	-	-	Mocha Oak
WTO	-	-	Toast Oak
WWO	-	-	Wheat Oak
WOW	-	-	Clear Walnut
WEW	-	-	Executive Walnut
WRW	-	-	Gray Luster Walnut
WGW	-	-	Gunstock Walnut
WJW	-	-	Judicial Walnut
WNW	-	-	Natural Walnut
WTW	-	-	Studio Teak Walnut
WWP	-	-	Full Fill Designer White

**3 SELECT AN EDGE**



Oval

**4 SELECT HARDWARE**

Hardware Option Not Available

**5 OPTIONS**

**FLUSH CUT**

- FC-B: Flush Unit Both Sides(Facing) for Ganging - \$95
- FC-L: Flush Unit Left (Facing) for Ganging - \$95
- FC-R: Flush Unit Right(Facing) for Ganging - \$95

**POWER**

- AirCharge offers a convenient way to charge any Qi compatible smartphone or device without the need to carry charging cables or find an available power outlet. Devices not equipped with the Qi technology, can be adapted to accept a charge with the AirCharge Wireless Receiver.
- ACWG: AirCharge Wireless Grommet (Black Aluminum) \$575
- ACWR: AirCharge Wireless Charging Receiver with Lightning Cable \$170
- Cover Power Pod (Linking/Non-Linking)
- PD-Cove: Non-Linking Rectangle Power Unit - \$550, For Table Top
- COV-DCH: Hardwire Infeed, 1 Linking Cove unit - \$710
- COV-DCP: Plug Infeed, 1 Linking Cove unit - \$765
- COV-DCL: Additional Units (includes 1 Linking Cove unit + 72" jumpers) - \$575

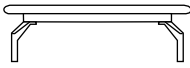

**PLATFORM - SEATING UNITS (CUSHION)**

**33 3/4" DEPTH ONE SEAT PLATFORM**

**STANDARD FEATURES**

- 1 1/4" Platform
- Polished Aluminum legs
- Platforms for a cushion feature a route to reduce unit weight

- Cushions (ordered separately) attach to platform with 4 bolts (Field Assembly Required). Cushions are reversible on platform.
- Each flush cut option reduces the platform width 5/8"

**NOTES**

- If platform for cushion is desired, use with 31-1/2" chair or 31-1/2" cushion
- AirCharge not available on Platform for Cushion

[CLICK HERE TO VIEW PRODUCT INDEX](#)

**1 SELECT A STYLE**

DIMENSIONS	STYLE NUMBER	LIST PRICE	STYLE NUMBER	LIST PRICE	STYLE NUMBER	LIST PRICE
W" x D" x H"	"W" Veneer Top Veneer Chassis		"G" High Pressure Laminate Top Veneer Chassis		"M" Thermally Fused Laminate Top Thermally Fused Laminate Chassis	
<b>Platform for Cushion (Cushion not Included)</b>						
33-3/4 x 33-3/4 x 8-1/2	TAB3333RPT01	964	"G" Option N/A		"M" Option N/A	
<b>Table Platform</b>						
33-3/4 x 33-3/4 x 8-1/2	TAB3333RPT00	964	"G" Option N/A		"M" Option N/A	

**2 SELECT A FINISH**

"W" Veneer	"G" HPL	"M" TFL	Finish
WAC	-	-	Amber Cherry
WRC	-	-	Caramel Cherry
WIC	-	-	Crimson Cherry
WEC	-	-	Ebony Cherry
WHC	-	-	Honey Cherry
WOC	-	-	KoKo Cherry
WSC	-	-	Scotch Cherry
WWC	-	-	Wheat Cherry
WAM	-	-	Alabaster Maple
WCM	-	-	Clear Maple
WWM	-	-	Wheat Maple
WBO	-	-	Blush Oak
WMO	-	-	Mocha Oak
WTO	-	-	Toast Oak
WWO	-	-	Wheat Oak
WOW	-	-	Clear Walnut
WEW	-	-	Executive Walnut
WRW	-	-	Gray Luster Walnut
WGW	-	-	Gunstock Walnut
WJW	-	-	Judicial Walnut
WNW	-	-	Natural Walnut
WTW	-	-	Studio Teak Walnut
WWP	-	-	Full Fill Designer White

**3 SELECT AN EDGE**



Oval

**4 SELECT HARDWARE**

Hardware Option Not Available

**5 OPTIONS**

**FLUSH CUT**

- FC-B: Flush Unit Both Sides(Facing) for Ganging - \$95
- FC-L: Flush Unit Left (Facing) for Ganging - \$95
- FC-R: Flush Unit Right(Facing) for Ganging - \$95

**POWER**

- AirCharge offers a convenient way to charge any Qi compatible smartphone or device without the need to carry charging cables or find an available power outlet. Devices not equipped with the Qi technology, can be adapted to accept a charge with the AirCharge Wireless Receiver.
- ACWG: AirCharge Wireless Grommet (Black Aluminum) \$575
  - ACWR: AirCharge Wireless Charging Receiver with Lightning Cable \$170
  - Cover Power Pod (Linking/Non-Linking)
  - PD-Cove: Non-Linking Rectangle Power Unit - \$550, For Table Top
  - COV-DCH: Hardwire Infeed, 1 Linking Cove unit - \$710
  - COV-DCP: Plug Infeed, 1 Linking Cove unit - \$765
  - COV-DCL: Additional Units (includes 1 Linking Cove unit + 72" jumpers) - \$575

PLATFORM - SEATING UNITS (CUSHION)



33 3/4" DEPTH TWO SEAT PLATFORM

STANDARD FEATURES

- 1 1/4" Platform
- Polished Aluminum legs
- Platforms for a cushion feature a route to reduce unit weight

- platform with 4 bolts (Field Assembly Required). Cushions are reversible on platform.
- Center leg is a black recessed support
- Each flush cut option reduces the platform width 5/8"

NOTES

- If platform for cushion is desired, use with 31-1/2" chair or 31-1/2" cushion
- AirCharge not available on TAB6633RPT05
- Cushions (ordered separately) attach to

[CLICK HERE TO VIEW PRODUCT INDEX](#)

1 SELECT A STYLE

DIMENSIONS	STYLE NUMBER	LIST PRICE	STYLE NUMBER	LIST PRICE	STYLE NUMBER	LIST PRICE
W" x D" x H"	WGT	"W" Veneer Top Veneer Chassis	"G" High Pressure Laminate Top Veneer Chassis	"M" Thermally Fused Laminate Top Thermally Fused Laminate Chassis		
<b>Platform for Left Facing Cushion (Cushion not Included)</b>						
66-1/4 x 33-3/4 x 8-1/2	95	TAB6633RPT02	1720	"G" Option N/A	"M" Option N/A	
<b>Platform for Right Facing Cushion (Cushion not Included)</b>						
66-1/4 x 33-3/4 x 8-1/2	95	TAB6633RPT03	1720	"G" Option N/A	"M" Option N/A	
<b>Platform for Left &amp; Right Facing Cushion (Cushion not Included)</b>						
66-1/4 x 33-3/4 x 8-1/2	85	TAB6633RPT05	1720	"G" Option N/A	"M" Option N/A	
<b>Table Platform</b>						
66-1/4 x 33-3/4 x 8-1/2	105	TAB6633RPT00	1720	"G" Option N/A	"M" Option N/A	

2 SELECT A FINISH

"W" Veneer	"G" HPL	"M" TFL	Finish
WAC	-	-	Amber Cherry
WRC	-	-	Caramel Cherry
WIC	-	-	Crimson Cherry
WEC	-	-	Ebony Cherry
WHC	-	-	Honey Cherry
WOC	-	-	KoKo Cherry
WSC	-	-	Scotch Cherry
WWC	-	-	Wheat Cherry
WAM	-	-	Alabaster Maple
WCM	-	-	Clear Maple
WWM	-	-	Wheat Maple
WBO	-	-	Blush Oak
WMO	-	-	Mocha Oak
WTO	-	-	Toast Oak
WWO	-	-	Wheat Oak
WOW	-	-	Clear Walnut
WEW	-	-	Executive Walnut
WRW	-	-	Gray Luster Walnut
WGW	-	-	Gunstock Walnut
WJW	-	-	Judicial Walnut
WNW	-	-	Natural Walnut
WTW	-	-	Studio Teak Walnut
WWP	-	-	Full Fill Designer White

3 SELECT AN EDGE



Oval

4 SELECT HARDWARE

Hardware Option Not Available

5 OPTIONS

FLUSH CUT

- FC-B: Flush Unit Both Sides(Facing) for Ganging - \$95
- FC-L: Flush Unit Left (Facing) for Ganging - \$95
- FC-R: Flush Unit Right(Facing) for Ganging - \$95

POWER

- AirCharge offers a convenient way to charge any Qi compatible smartphone or device without the need to carry charging cables or find an available power outlet. Devices not equipped with the Qi technology, can be adapted to accept a charge with the AirCharge Wireless Receiver.
- ACWG: AirCharge Wireless Grommet (Black Aluminum) \$575
  - ACWR: AirCharge Wireless Charging Receiver with Lightning Cable \$170
  - Cover Power Pod (Linking/Non-Linking)
  - PD-Cove: Non-Linking Rectangle Power Unit - \$550, For Table Top
  - COV-DCH: Hardwire Infeed, 1 Linking Cove unit - \$710
  - COV-DCP: Plug Infeed, 1 Linking Cove unit - \$765
  - COV-DCL: Additional Units (includes 1 Linking Cove unit + 72" jumpers) - \$575

**PLATFORM - INSIDE RADIUS SEATING UNIT (CUSHION)**

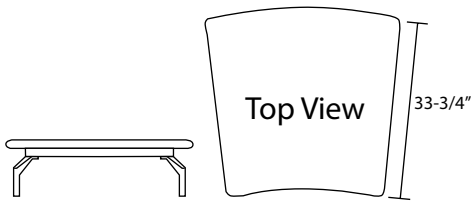

**15 DEGREE INSIDE RADIUS PLATFORM**

**STANDARD FEATURES**

- 1 1/4" Platform
- Polished Aluminum legs
- Platforms for a cushion feature a route to reduce unit weight

- Cushions (ordered separately) attach to platform with 4 bolts (Field Assembly Required). Cushions are reversible on platform.
- Each flush cut option reduces the platform width 5/8"

**NOTES**

- If platform for cushion is desired, use with 31-1/2" chair or 31-1/2" cushion
- AirCharge not available on Platform for Cushion

[CLICK HERE TO VIEW PRODUCT INDEX](#)

**1 SELECT A STYLE**

DIMENSIONS		STYLE NUMBER	LIST PRICE	STYLE NUMBER	LIST PRICE	STYLE NUMBER	LIST PRICE
W" x D" x H"	WGT	"W" Veneer Top Veneer Chassis		"G" High Pressure Laminate Top HPL Veneer Chassis		"M" Thermally Fused Laminate Top Thermally Fused Laminate Chassis	
<b>Platform for Cushion (Cushion not Included)</b>							
42-1/2 x 35-1/2 x 8-1/2	60	TAB4236ISP01	1090	"G" Option N/A		"M" Option N/A	
<b>Table Platform</b>							
42-1/2 x 35-1/2 x 8-1/2	70	TAB4236ISP00	1090	"G" Option N/A		"M" Option N/A	

**2 SELECT A FINISH**

"W" Veneer	"G" HPL	"M" TFL	
WAC	-	-	Amber Cherry
WRC	-	-	Caramel Cherry
WIC	-	-	Crimson Cherry
WEC	-	-	Ebony Cherry
WHC	-	-	Honey Cherry
WOC	-	-	KoKo Cherry
WSC	-	-	Scotch Cherry
WWC	-	-	Wheat Cherry
WAM	-	-	Alabaster Maple
WCM	-	-	Clear Maple
WWM	-	-	Wheat Maple
WBO	-	-	Blush Oak
WMO	-	-	Mocha Oak
WTO	-	-	Toast Oak
WWO	-	-	Wheat Oak
WOW	-	-	Clear Walnut
WEW	-	-	Executive Walnut
WRW	-	-	Gray Luster Walnut
WGW	-	-	Gunstock Walnut
WJW	-	-	Judicial Walnut
WNW	-	-	Natural Walnut
WTW	-	-	Studio Teak Walnut
WWP	-	-	Full Fill Designer White

**3 SELECT AN EDGE**



**4 SELECT HARDWARE**

Hardware Option Not Available

**5 OPTIONS**

**FLUSH CUT**

- FC-B: Flush Unit Both Sides(Facing) for Ganging - \$95
- FC-L: Flush Unit Left (Facing) for Ganging - \$95
- FC-R: Flush Unit Right(Facing) for Ganging - \$95

**POWER**

- AirCharge offers a convenient way to charge any Qi compatible smartphone or device without the need to carry charging cables or find an available power outlet. Devices not equipped with the Qi technology, can be adapted to accept a charge with the AirCharge Wireless Receiver.
- ACWG: AirCharge Wireless Grommet (Black Aluminum) \$575
  - ACWR: AirCharge Wireless Charging Receiver with Lightning Cable \$170
  - Cover Power Pod (Linking/Non-Linking)
  - PD-Cove: Non-Linking Rectangle Power Unit - \$550, For Table Top
  - COV-DCH: Hardwire Infeed, 1 Linking Cove unit - \$710
  - COV-DCP: Plug Infeed, 1 Linking Cove unit - \$765
  - COV-DCL: Additional Units (includes 1 Linking Cove unit + 72" jumpers) - \$575

**PLATFORM - INSIDE RADIUS SEATING UNIT (CUSHION)**

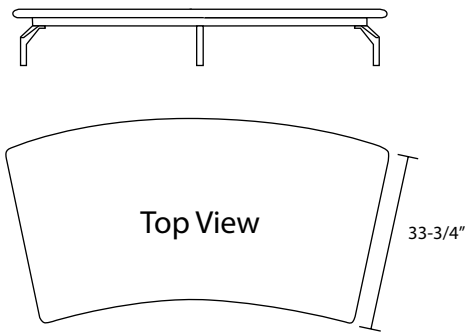

**30 DEGREE INSIDE RADIUS PLATFORM**

**STANDARD FEATURES**

- 1 1/4" Platform
- Polished Aluminum legs
- Platforms for a cushion feature a route to reduce unit weight

- platform with 4 bolts (Field Assembly Required). Cushions on 30 degree radius platform are NOT reversible.
- Center leg is a black recessed support
- Each flush cut option reduces the platform width 5/8"

**NOTES**

- If platform for cushion is desired, use with 31-1/2" chair or 31-1/2" cushion
- AirCharge not available on TAB9539ISP05
- Cushions (ordered separately) attach to

[CLICK HERE TO VIEW PRODUCT INDEX](#)

**1 SELECT A STYLE**

DIMENSIONS		STYLE NUMBER	LIST PRICE	STYLE NUMBER	LIST PRICE	STYLE NUMBER	LIST PRICE
W" x D" x H"	WGT	"W" Veneer Top Veneer Chassis		"G" HPL High Pressure Laminate Top Veneer Chassis		"M" TFL Thermally Fused Laminate Top Thermally Fused Laminate Chassis	
<b>Platform for Left Facing Cushion (Cushion not Included)</b>							
94-1/2 x 39 x 8-1/2	105	TAB9539ISP02	1996	"G" Option N/A		"M" Option N/A	
<b>Platform for Right Facing Cushion (Cushion not Included)</b>							
94-1/2 x 39 x 8-1/2	105	TAB9539ISP03	1996	"G" Option N/A		"M" Option N/A	
<b>Platform for Left &amp; Right Facing Cushion (Cushion not Included)</b>							
94-1/2 x 39 x 8-1/2	95	TAB9539ISP05	1996	"G" Option N/A		"M" Option N/A	
<b>Table Platform</b>							
94-1/2 x 39 x 8-1/2	115	TAB9539ISP00	1996	"G" Option N/A		"M" Option N/A	

**2 SELECT A FINISH**

"W" Veneer	"G" HPL	"M" TFL	
WAC	-	-	Amber Cherry
WRC	-	-	Caramel Cherry
WIC	-	-	Crimson Cherry
WEC	-	-	Ebony Cherry
WHC	-	-	Honey Cherry
WOC	-	-	KoKo Cherry
WSC	-	-	Scotch Cherry
WWC	-	-	Wheat Cherry
WAM	-	-	Alabaster Maple
WCM	-	-	Clear Maple
WWM	-	-	Wheat Maple
WBO	-	-	Blush Oak
WMO	-	-	Mocha Oak
WTO	-	-	Toast Oak
WWO	-	-	Wheat Oak
WOW	-	-	Clear Walnut
WEW	-	-	Executive Walnut
WRW	-	-	Gray Luster Walnut
WGW	-	-	Gunstock Walnut
WJW	-	-	Judicial Walnut
WNW	-	-	Natural Walnut
WTW	-	-	Studio Teak Walnut
WWP	-	-	Full Fill Designer White

**3 SELECT AN EDGE**



**4 SELECT HARDWARE**

Hardware Option Not Available

**5 OPTIONS**

**FLUSH CUT**

- FC-B: Flush Unit Both Sides(Facing) for Ganging - \$95
- FC-L: Flush Unit Left (Facing) for Ganging - \$95
- FC-R: Flush Unit Right(Facing) for Ganging - \$95

**POWER**

- AirCharge offers a convenient way to charge any Qi compatible smartphone or device without the need to carry charging cables or find an available power outlet. Devices not equipped with the Qi technology, can be adapted to accept a charge with the AirCharge Wireless Receiver.
- ACWG: AirCharge Wireless Grommet (Black Aluminum) \$575
  - ACWR: AirCharge Wireless Charging Receiver with Lightning Cable \$170
  - Cover Power Pod (Linking/Non-Linking)
  - PD-Cove: Non-Linking Rectangle Power Unit - \$550, For Table Top
  - COV-DCH: Hardwire Infeed, 1 Linking Cove unit - \$710
  - COV-DCP: Plug Infeed, 1 Linking Cove unit - \$765
  - COV-DCL: Additional Units (includes 1 Linking Cove unit + 72" jumpers) - \$575

**PLATFORM - OUTSIDE RADIUS SEATING UNIT (CUSHION)**

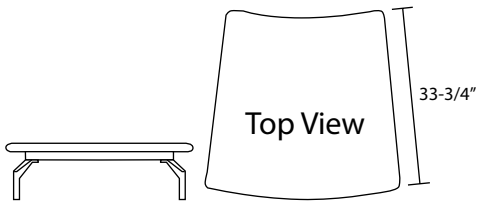

**15 DEGREE OUTSIDE RADIUS PLATFORM**

**STANDARD FEATURES**

- 1 1/4" Platform
- Polished Aluminum legs
- Platforms for a cushion feature a route to reduce unit weight

- Cushions (ordered separately) attach to platform with 4 bolts (Field Assembly Required). Cushions are reversible on platform.
- Each flush cut option reduces the platform width 5/8"

**NOTES**

- If platform for cushion is desired, use with 31-1/2" chair or 31-1/2" cushion
- AirCharge not available on Platform for Cushion

[CLICK HERE TO VIEW PRODUCT INDEX](#)

**1 SELECT A STYLE**

DIMENSIONS	STYLE NUMBER	LIST PRICE	STYLE NUMBER	LIST PRICE	STYLE NUMBER	LIST PRICE
W" x D" x H"	WGT	"W" Veneer Top Veneer Chassis	"G" High Pressure Laminate Top Veneer Chassis	"M" Thermally Fused Laminate Top Thermally Fused Laminate Chassis		
<b>Platform for Cushion (Cushion not Included)</b>						
42-1/2 x 35-1/2 x 8-1/2	60	TAB4236OSP01	1090	"G" Option N/A	"M" Option N/A	
<b>Table Platform</b>						
42-1/2 x 35-1/2 x 8-1/2	70	TAB4236OSP00	1090	"G" Option N/A	"M" Option N/A	

**2 SELECT A FINISH**

"W" Veneer	"G" HPL	"M" TFL
WAC	-	Amber Cherry
WRC	-	Caramel Cherry
WIC	-	Crimson Cherry
WEC	-	Ebony Cherry
WHC	-	Honey Cherry
WOC	-	KoKo Cherry
WSC	-	Scotch Cherry
WWC	-	Wheat Cherry
WAM	-	Alabaster Maple
WCM	-	Clear Maple
WWM	-	Wheat Maple
WBO	-	Blush Oak
WMO	-	Mocha Oak
WTO	-	Toast Oak
WWO	-	Wheat Oak
WOW	-	Clear Walnut
WEW	-	Executive Walnut
WRW	-	Gray Luster Walnut
WGW	-	Gunstock Walnut
WJW	-	Judicial Walnut
WNW	-	Natural Walnut
WTW	-	Studio Teak Walnut
WWP	-	Full Fill Designer White

**3 SELECT AN EDGE**



Oval

**4 SELECT HARDWARE**

Hardware Option Not Available

**5 OPTIONS**

**FLUSH CUT**

- FC-B: Flush Unit Both Sides(Facing) for Ganging - \$95
- FC-L: Flush Unit Left (Facing) for Ganging - \$95
- FC-R: Flush Unit Right(Facing) for Ganging - \$95

**POWER**

- AirCharge offers a convenient way to charge any Qi compatible smartphone or device without the need to carry charging cables or find an available power outlet. Devices not equipped with the Qi technology, can be adapted to accept a charge with the AirCharge Wireless Receiver.
- ACWG: AirCharge Wireless Grommet (Black Aluminum) \$575
  - ACWR: AirCharge Wireless Charging Receiver with Lightning Cable \$170
  - Cover Power Pod (Linking/Non-Linking)
  - PD-Cove: Non-Linking Rectangle Power Unit - \$550, For Table Top
  - COV-DCH: Hardwire Infeed, 1 Linking Cove unit - \$710
  - COV-DCP: Plug Infeed, 1 Linking Cove unit - \$765
  - COV-DCL: Additional Units (includes 1 Linking Cove unit + 72" jumpers) - \$575

**PLATFORM - OUTSIDE RADIUS SEATING UNIT (CUSHION)**

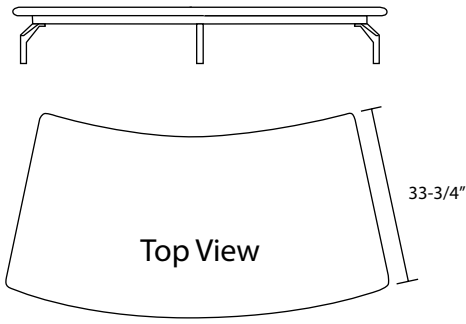

**30 DEGREE OUTSIDE RADIUS PLATFORM**

**STANDARD FEATURES**

- 1 1/4" Platform
- Polished Aluminum legs
- Platforms for a cushion feature a route to reduce unit weight

- platform with 4 bolts (Field Assembly Required). Cushions on 30 Degree radius platform are NOT reversible.
- Center leg is a black recessed support
- Each flush cut option reduces the platform width 5/8"

**NOTES**

- If platform for cushion is desired, use with 31-1/2" chair or 31-1/2" cushion
- AirCharge not available on TAB9539OSP05
- Cushions (ordered separately) attach to

[CLICK HERE TO VIEW PRODUCT INDEX](#)

**1 SELECT A STYLE**

DIMENSIONS	STYLE NUMBER	LIST PRICE	STYLE NUMBER	LIST PRICE	STYLE NUMBER	LIST PRICE
W" x D" x H"	WGT	"W" Veneer Top Veneer Chassis	"G" High Pressure Laminate Top Veneer Chassis	"M" Thermally Fused Laminate Top Thermally Fused Laminate Chassis		
<b>Platform for Left Facing Cushion (Cushion not Included)</b>						
94-1/2 x 39 x 8-1/2	105	TAB9539OSP02	1996	"G" Option N/A	"M" Option N/A	
<b>Platform for Right Facing Cushion (Cushion not Included)</b>						
94-1/2 x 39 x 8-1/2	105	TAB9539OSP03	1996	"G" Option N/A	"M" Option N/A	
<b>Platform for Left &amp; Right Facing Cushion (Cushion not Included)</b>						
94-1/2 x 39 x 8-1/2	95	TAB9539OSP05	1996	"G" Option N/A	"M" Option N/A	
<b>Table Platform</b>						
94-1/2 x 39 x 8-1/2	115	TAB9539OSP00	1996	"G" Option N/A	"M" Option N/A	

**2 SELECT A FINISH**

"W" Veneer	"G" HPL	"M" TFL	
WAC	-	-	Amber Cherry
WRC	-	-	Caramel Cherry
WIC	-	-	Crimson Cherry
WEC	-	-	Ebony Cherry
WHC	-	-	Honey Cherry
WOC	-	-	KoKo Cherry
WSC	-	-	Scotch Cherry
WWC	-	-	Wheat Cherry
WAM	-	-	Alabaster Maple
WCM	-	-	Clear Maple
WWM	-	-	Wheat Maple
WBO	-	-	Blush Oak
WMO	-	-	Mocha Oak
WTO	-	-	Toast Oak
WWO	-	-	Wheat Oak
WOW	-	-	Clear Walnut
WEW	-	-	Executive Walnut
WRW	-	-	Gray Luster Walnut
WGW	-	-	Gunstock Walnut
WJW	-	-	Judicial Walnut
WNW	-	-	Natural Walnut
WTW	-	-	Studio Teak Walnut
WWP	-	-	Full Fill Designer White

**3 SELECT AN EDGE**



Oval

**4 SELECT HARDWARE**

Hardware Option Not Available

**5 OPTIONS**

**FLUSH CUT**

- FC-B: Flush Unit Both Sides(Facing) for Ganging - \$95
- FC-L: Flush Unit Left (Facing) for Ganging - \$95
- FC-R: Flush Unit Right(Facing) for Ganging - \$95

**POWER**

- AirCharge offers a convenient way to charge any Qi compatible smartphone or device without the need to carry charging cables or find an available power outlet. Devices not equipped with the Qi technology, can be adapted to accept a charge with the AirCharge Wireless Receiver.
- ACWG: AirCharge Wireless Grommet (Black Aluminum) \$575
- ACWR: AirCharge Wireless Charging Receiver with Lightning Cable \$170
- Cover Power Pod (Linking/Non-Linking)
- PD-Cove: Non-Linking Rectangle Power Unit - \$550, For Table Top
- COV-DCH: Hardwire Infeed, 1 Linking Cove unit - \$710
- COV-DCP: Plug Infeed, 1 Linking Cove unit - \$765
- COV-DCL: Additional Units (includes 1 Linking Cove unit + 72" jumpers) - \$575

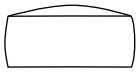

**19 1/2" ONE SEAT BENCH CUSHION**

**STANDARD FEATURES**

- Frame constructed of CNC cut Plywood components featuring interlocking tab joinery for superior strength and long term durability.
- Joints are securely fastened with corner block construction.
- Seats and back are webbed to enhance comfort, sustainability and endurance.
- 4" Top cushion

**Notes**

- Use with 21-3/4" bench platform
- Seating Units should be ordered in addition to a platform. Multiple platforms can be ganged with a flush cut option to create various arrangements.
- Cushion is reversible on all platforms except 30 Degree Radius

[CLICK HERE TO VIEW PRODUCT INDEX](#)

**1 SELECT UPHOLSTERY GRADE**

STYLE	COM	COL	1	2	3	4	5	6	7	8	9	10	11/L1	12	13/L2
TAB1919OSB01	710	710	803	848	893	938	983	1028	1073	1118	1163	1208	1298	1343	1388

**2 SELECT A FINISH** | **3 OPTIONS**

Finishes N/A

**Power**

- Cover Power Pod (Linking/Non-Linking)
- PD-Cove: Non-Linking Rectangle Power Unit - \$550, For Table Top
- COV-DCH: Hardwire Infeed, 1 Linking Cove unit - \$710
- COV-DCP: Plug Infeed, 1 Linking Cove unit - \$765
- COV-DCL: Additional Units (includes 1 Linking Cove unit + 72" jumpers) - \$575





**31-1/2" ONE SEAT BENCH CUSHION**

**STANDARD FEATURES**

- Frame constructed of CNC cut Plywood components featuring interlocking tab joinery for superior strength and long term durability.
- Joints are securely fastened with corner block construction.
- Seats and back are webbed to enhance comfort, sustainability and endurance.
- 4" Top cushion

**Notes**

- Seating Units should be ordered in addition to a platform. Multiple platforms can be ganged with a flush cut option to create various arrangements.
- For 33-3/4" deep & radius platforms
- Cushion is reversible on all platforms except 30 Degree Radius

[CLICK HERE TO VIEW PRODUCT INDEX](#)

**1 SELECT UPHOLSTERY GRADE**

STYLE	COM	COL	1	2	3	4	5	6	7	8	9	10	11/L1	12	13/L2
TAB3131OSB01	815	815	926	981	1036	1091	1146	1201	1256	1311	1366	1421	1531	1586	1641

**2 SELECT A FINISH** | **3 OPTIONS**

Finishes N/A

- Power**
- Cover Power Pod (Linking/Non-Linking)
  - PD-Cove: Non-Linking Rectangle Power Unit - \$550, For Table Top
  - COV-DCH: Hardwire Infeed, 1 Linking Cove unit - \$710
  - COV-DCP: Plug Infeed, 1 Linking Cove unit - \$765
  - COV-DCL: Additional Units (includes 1 Linking Cove unit + 72" jumpers) - \$575

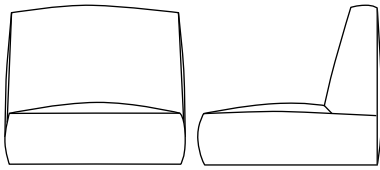

**ARMLESS CHAIR CUSHION**

**STANDARD FEATURES**

- Frame constructed of CNC cut Plywood components featuring interlocking tab joinery for superior strength and long term durability.
- Joints are securely fastened with corner block construction.
- Seats and back are webbed to enhance comfort, sustainability and endurance.
- 4" Top cushion

**Notes**

- Seating Units should be ordered in addition to a platform. Multiple platforms can be ganged with a flush cut option to create various arrangements.
- For 33-3/4" deep & radius platforms
- Cushion is reversible on all platforms except 30 Degree Radius

[CLICK HERE TO VIEW PRODUCT INDEX](#)

**1 SELECT UPHOLSTERY GRADE**

STYLE	COM	COL	1	2	3	4	5	6	7	8	9	10	11/L1	12	13/L2
TAB3131NAC01	1550	1550	1806	1934	2062	2140	2318	2446	2574	2702	2830	2958	3214	3342	3470

**2 SELECT A FINISH** | **3 OPTIONS**

Finishes N/A

- Power**
- Cover Power Pod (Linking/Non-Linking)
  - PD-Cove: Non-Linking Rectangle Power Unit - \$550, For Table Top
  - COV-DCH: Hardwire Infeed, 1 Linking Cove unit - \$710
  - COV-DCP: Plug Infeed, 1 Linking Cove unit - \$765
  - COV-DCL: Additional Units (includes 1 Linking Cove unit + 72" jumpers) - \$575

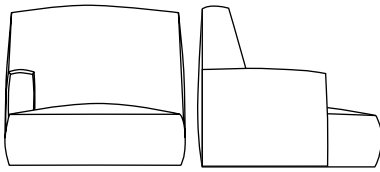

**LEFT ARM (FACING) CHAIR CUSHION**

**STANDARD FEATURES**

- Frame constructed of CNC cut Plywood components featuring interlocking tab joinery for superior strength and long term durability.
- Joints are securely fastened with corner block construction.
- Seats and back are webbed to enhance comfort, sustainability and endurance.
- 4" Top cushion

**Notes**

- Seating Units should be ordered in addition to a platform. Multiple platforms can be ganged with a flush cut option to create various arrangements.
- For 33-3/4" deep & radius platforms
- Cushion is reversible on all platforms except 30 Degree Radius

[CLICK HERE TO VIEW PRODUCT INDEX](#)

**1 SELECT UPHOLSTERY GRADE**

STYLE	COM	COL	1	2	3	4	5	6	7	8	9	10	11/L1	12	13/L2
TAB3131LAC01	1625	1625	1881	2009	2137	2265	2393	2521	2649	2777	2905	3033	3289	3417	3545

**2 SELECT A FINISH** | **3 OPTIONS**

Finishes N/A

- Power**
- Cover Power Pod (Linking/Non-Linking)
  - PD-Cove: Non-Linking Rectangle Power Unit - \$550, For Table Top
  - COV-DCH: Hardwire Infeed, 1 Linking Cove unit - \$710
  - COV-DCP: Plug Infeed, 1 Linking Cove unit - \$765
  - COV-DCL: Additional Units (includes 1 Linking Cove unit + 72" jumpers) - \$575

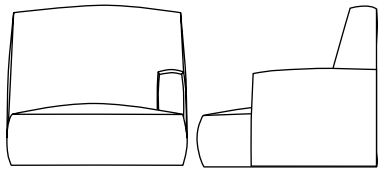

**RIGHT ARM (FACING) CHAIR CUSHION**

**STANDARD FEATURES**

- Frame constructed of CNC cut Plywood components featuring interlocking tab joinery for superior strength and long term durability.
- Joints are securely fastened with corner block construction.
- Seats and back are webbed to enhance comfort, sustainability and endurance.
- 4" Top cushion

**Notes**

- Seating Units should be ordered in addition to a platform. Multiple platforms can be ganged with a flush cut option to create various arrangements.
- For 33-3/4" deep & radius platforms
- Cushion is reversible on all platforms except 30 Degree Radius

[CLICK HERE TO VIEW PRODUCT INDEX](#)

**1 SELECT UPHOLSTERY GRADE**

STYLE	COM	COL	1	2	3	4	5	6	7	8	9	10	11/L1	12	13/L2
TAB3131RAC01	1625	1625	1881	2009	2137	2265	2393	2521	2649	2777	2905	3033	3289	3417	3545

**2 SELECT A FINISH** | **3 OPTIONS**

Finishes N/A

- Power**
- Cover Power Pod (Linking/Non-Linking)
  - PD-Cove: Non-Linking Rectangle Power Unit - \$550, For Table Top
  - COV-DCH: Hardwire Infeed, 1 Linking Cove unit - \$710
  - COV-DCP: Plug Infeed, 1 Linking Cove unit - \$765
  - COV-DCL: Additional Units (includes 1 Linking Cove unit + 72" jumpers) - \$575

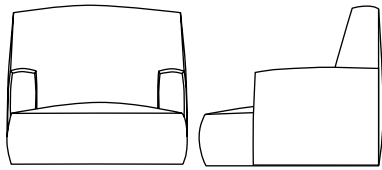

**LOUNGE CHAIR CUSHION**

**STANDARD FEATURES**

- Frame constructed of CNC cut Plywood components featuring interlocking tab joinery for superior strength and long term durability.
- Joints are securely fastened with corner block construction.
- Seats and back are webbed to enhance comfort, sustainability and endurance.
- 4" Top cushion

**Notes**

- Seating Units should be ordered in addition to a platform. Multiple platforms can be ganged with a flush cut option to create various arrangements.
- For 33-3/4" deep & radius platforms
- Cushion is reversible on all platforms except 30 Degree Radius

[CLICK HERE TO VIEW PRODUCT INDEX](#)

**1 SELECT UPHOLSTERY GRADE**

STYLE	COM	COL	1	2	3	4	5	6	7	8	9	10	11/L1	12	13/L2
TAB3131DAC01	2005	2005	2300	2446	2592	2738	2884	3030	3176	3322	3468	3614	3906	4052	4198

**2 SELECT A FINISH** | **3 OPTIONS**

Finishes N/A

- Power**
- Cover Power Pod (Linking/Non-Linking)
  - PD-Cove: Non-Linking Rectangle Power Unit - \$550, For Table Top
  - COV-DCH: Hardwire Infeed, 1 Linking Cove unit - \$710
  - COV-DCP: Plug Infeed, 1 Linking Cove unit - \$765
  - COV-DCL: Additional Units (includes 1 Linking Cove unit + 72" jumpers) - \$575

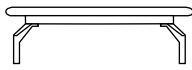

**20" DEPTH OTTOMAN PLATFORM**

**STANDARD FEATURES**

- 1 1/4" Platform
- Polished Aluminum legs

**NOTES**

- Cushions (ordered separately) attach to platform with 4 bolts (Field Assembly Required). Cushions are reversible on platforms.
- Ottoman features a route to reduce unit weight

[CLICK HERE TO VIEW PRODUCT INDEX](#)

**1 SELECT A STYLE**

DIMENSIONS		STYLE NUMBER	LIST PRICE	STYLE NUMBER	LIST PRICE	STYLE NUMBER	LIST PRICE
W" x D" x H"	WGT	<b>"W"</b> Veneer Top Veneer Chassis		<b>"G"</b> HPL High Pressure Laminate Top Veneer Chassis		<b>"M"</b> TFL Thermally Fused Laminate Top Thermally Fused Laminate Chassis	
33-3/4" x 20" x 8-1/2"	30	TAB3320RPT01	930	"G" Option N/A		"M" Option N/A	

**2 SELECT A FINISH**

"W" Veneer	"G" HPL	"M" TFL	
WAC	-	-	Amber Cherry
WRC	-	-	Caramel Cherry
WIC	-	-	Crimson Cherry
WEC	-	-	Ebony Cherry
WHC	-	-	Honey Cherry
WOC	-	-	KoKo Cherry
WSC	-	-	Scotch Cherry
WWC	-	-	Wheat Cherry
WAM	-	-	Alabaster Maple
WCM	-	-	Clear Maple
WWM	-	-	Wheat Maple
WBO	-	-	Blush Oak
WMO	-	-	Mocha Oak
WTO	-	-	Toast Oak
WWO	-	-	Wheat Oak
WOW	-	-	Clear Walnut
WEW	-	-	Executive Walnut
WRW	-	-	Gray Luster Walnut
WGW	-	-	Gunstock Walnut
WJW	-	-	Judicial Walnut
WNW	-	-	Natural Walnut
WTW	-	-	Studio Teak Walnut
WWP	-	-	Full Fill Designer White

**3 SELECT AN EDGE**



**5 OPTIONS**

N/A

**4 SELECT HARDWARE**

Hardware  
Option Not  
Available



SEATING UNIT - OTTOMAN

18" OTTOMAN CUSHION

STANDARD FEATURES

- Frame constructed of CNC cut Plywood components featuring interlocking tab joinery for superior strength and long term durability.
- Joints are securely fastened with corner block construction.
- 4" Top cushion

to Ottoman Platform. Multiple platforms can be ganged with a flush cut option to create various arrangements.

Notes

- Use on Ottoman platforms only
- Ottoman cushion should be ordered in addition

[CLICK HERE TO VIEW PRODUCT INDEX](#)

1 SELECT UPHOLSTERY GRADE

STYLE	COM	COL	1	2	3	4	5	6	7	8	9	10	11/L1	12	13/L2
TAB3118OSB01	710	710	803	848	893	938	983	1028	1073	1118	1163	1208	1298	1343	1388

2 SELECT A FINISH | 3 OPTIONS

Finishes N/A

N/A

**AIRCHARGE WIRELESS CHARGING GROMMET**

STYLE NUMBER	LIST PRICE
 ACWG WIRELESS GROMMET	\$575
ACWR WIRELESS RECEIVER W/ LIGHTNING CABLE	\$170



**SPECIFICATIONS**

- AirCharge offers a convenient way to charge any Qi compatible smartphone or device without the need to carry charging cables or find an available power outlet. Devices not equipped with the Qi technology, can be adapted to accept a charge from the grommet with the AirCharge Wireless Receiver.
- Size: 3.33”DIA x .75”D
- Compatible with an Qi rated device, Contact Customer Service for compatibility list
- Non-Qi device can be adapted to accept AirCharge unit with an ACWR AirCharge Wireless Receiver (compatible with iPhone)
- Surface Mount
- 78” Cord
- Standard Black Aluminum Finish; Available in White Aluminum or Black Finish upon request

**AVAILABLE**

- All Darran Collections

AirCharge Wireless Grommet



iphone w/ ACWR



Black Aluminum



Black Finish



White Aluminum



## COVE POWER UNIT - NON-LINKING

STYLE NUMBER	LIST PRICE
 PD COVE PLUG Non-Linking Version	\$550

**SPECIFICATIONS**

- Size 5.75" L x 2.5" W
- (2) 15 Amp Receptacles and (2) USB charging ports
- Surface Mount
- 108" Cord
- Standard Silver Finish, Available in White or Black Finish upon request
- ETL Listed

**AVAILABLE**

- All Darran Collections



## COVE POWER UNIT WITH DAISYLINK

### STYLE NUMBER

### LIST PRICE

#### STARTER UNITS



#### COV-DCH HARDWIRED

\$710

Includes (1) Cove unit with Hardwire Infeed - 120"



#### COV-DCP PLUG

\$800

Includes (1) Cove unit with Plug infeed - Includes 72" Cord and 32" Infeed Jumper for 104" total cord infeed

#### ADDITIONAL LINKING UNITS

#### COV-DCL

\$575 EACH

Includes Linking Cove unit and Jumper up to 96", cable length determined by the top size

### SPECIFICATIONS

- Size: 5.75" L x 2.5" W
- (2) 15 Amp Receptacles and (2) 2.1 Amp USB charging ports
- Surface Mount
- Max Daisy Chain - Hardwire - (9) units; Plug/Corded - (4) units
- Standard Silver Finish, Available in White or Black Finish upon request
- ETL Listed

### AVAILABLE

- All Darran Collections



**COVE CORDED SERIES**

**STYLE NUMBER**

**LIST PRICE**



PD-COVE-PKO

\$800



**SPECIFICATIONS**

- Size 9.5”L x 2.5”W x 3.18”D
- (2) Power Receptacles, (2) 2.1 Amp USB charging ports and (1) Telecom Plate Knockout
- Surface Mount
- 108” Cord
- Standard Silver Finish, Available in White or Black Finish upon request
- ETL Listed

**AVAILABLE**

- All Darran Collections

**TELECOM PLATES**

*THIS POD CAN HAVE UP TO 1 TOTAL PLATES*

STYLE NUMBER	LIST PRICE
RJ45 (1)	\$35
RJ45 (2)	\$70
RJ45 (3)	\$105
USB (1)	\$70
USB (2)	\$140
RJ11/RJ45	\$70
RJ45/USB	\$105
RJ45/HDMI	\$190
HDMI/DVI	\$325
HDMI/USB	\$205
HDMI/VGA	\$240
VGA/MINI-STEREO	\$155
VGA/USB	\$175